

ASTERION HR are sealed maintenance-free lead-acid batteries with gas recombination system (VRLA). Are manufactured by AGM technology (electrolyte absorbed in glass fiber separators). Thanks to this technology the batteries do not require the distillate refilling throughout the entire service life. HR refers to a range of ASTERION UPS series, specifically designed for use in UPS Data Centers, communication systems and other equipment.



Battery construction

Element	Positive plate	Negative plate	Case	Lid	Valve	Terminal	Separator	Electrolyte
Material	Lead dioxide	Lead	ABS		Rubber	Copper	Fiberglass	Acid

Specifications

Nominal voltage.....6 V
 Cell.....3
 Design life.....8 years
 Nominal capacity (25°C)
 20 hours rate (0,225 A; 1,75 V/cell).....4,5 Ah
 10 hours rate (0,427 A; 1,75 V/cell).....4,27 Ah
 5 hours rate (0,79 A; 1,75 V/cell).....3,95 Ah
 Self-discharge.....3% capacity per month 25°C
 Internal resistance (25°C).....20 mΩ

Operating temperature range

Discharge.....-20÷60°C
 Charge.....-10÷60°C
 Storage.....-20÷60°C
 Maximum discharge current (25°C).....67,5A (5sec)
 Cycle mode (2,35÷2,4 V/cell)
 Max.charge current.....1,35 A
 Temperature correction factor.....15 mV/°C
 Standby mode (2,25÷2,3 V/cell)
 Temperature correction factor.....10 mV/°C

Application

- Uninterruptable power supply
- Back up power supply
- Medical devices
- Renewable energy systems
- Portable devices
- Professional equipment

Performance & characteristics

- AGM technology allows to recombine 99% of the generated gas;
- No restrictions on air transportation;
- Compliance with the UL requirements;
- Lead plates, alloyed by calcium, provide high energy density;
- Maintenance-free. Do not require distillate topping;
- Long service life;
- The battery case is made of flame-retardant ABS plastic.

Dimensions (±2mm)

Length, mm.....70
 Width, mm.....47
 Height, mm.....101
 Height over terminals, mm.....107
 Weight (±3%), kg.....0,85

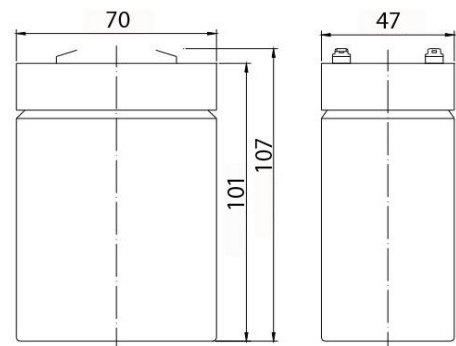

Layout

A



Terminal type

F1

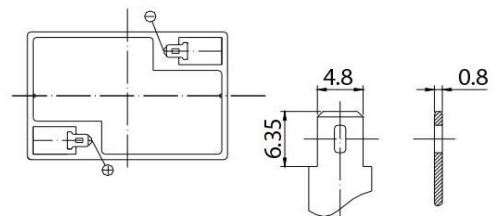
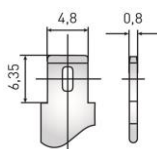

Discharge Constant Current, A (25°C)

V/cell	5 min	10 min	15 min	30 min	1 h	3 h	5 h	10 h	20 h
1,60	17,6	14,3	9,90	5,28	3,37	1,37	0,86	0,46	0,24
1,65	16,7	13,6	9,46	5,07	3,25	1,33	0,84	0,45	0,23
1,70	15,7	12,9	9,01	4,85	3,12	1,28	0,81	0,44	0,23
1,75	14,8	12,2	8,54	4,61	2,98	1,23	0,79	0,43	0,23
1,80	13,8	11,5	8,06	4,37	2,84	1,17	0,76	0,42	0,22

Discharge Constant Power, W/cell (25°C)

V/cell	5 min	10 min	15 min	30 min	1 h	3 h	5 h	10 h	20 h
1,60	33,3	24,0	18,7	11,0	6,67	2,59	1,73	0,91	0,45
1,65	31,3	22,6	17,7	10,5	6,39	2,53	1,70	0,90	0,45
1,70	29,2	21,2	16,6	9,89	6,09	2,46	1,67	0,89	0,44
1,75	27,2	19,8	15,6	9,31	5,79	2,39	1,63	0,87	0,44
1,80	25,2	18,4	14,6	8,73	5,48	2,31	1,59	0,86	0,43

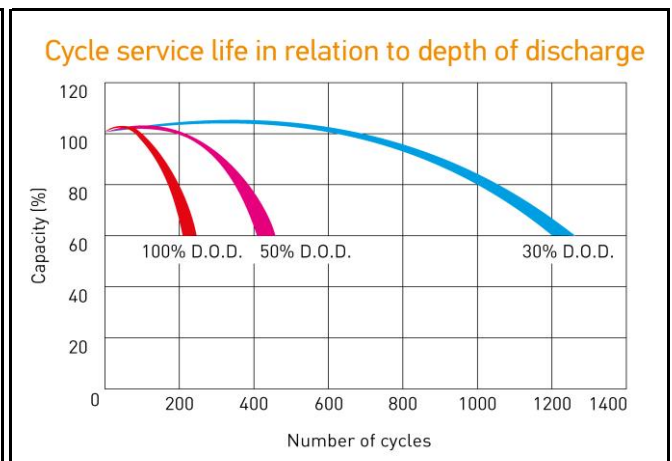
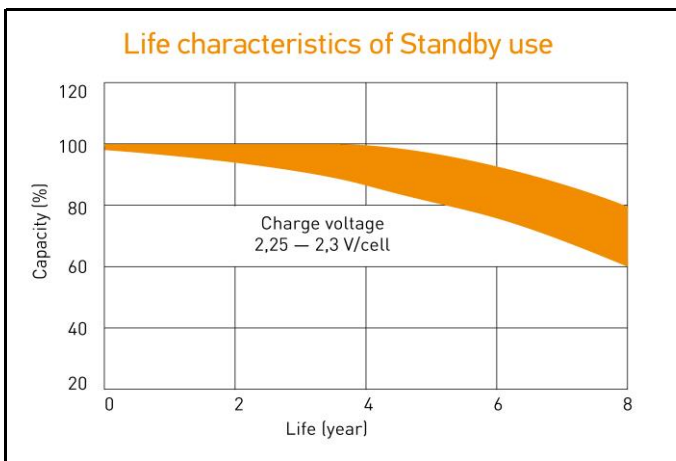
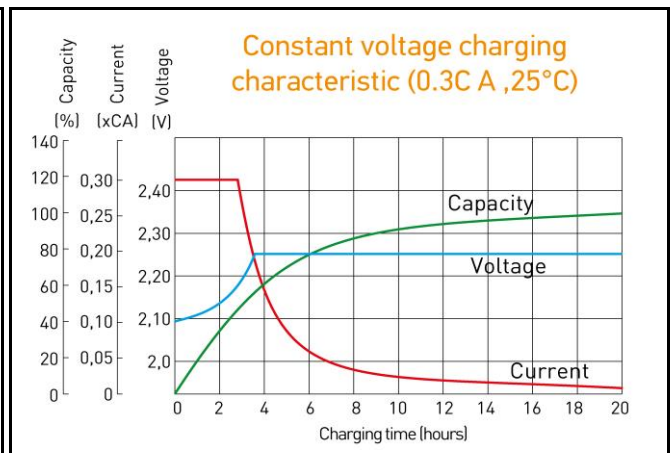
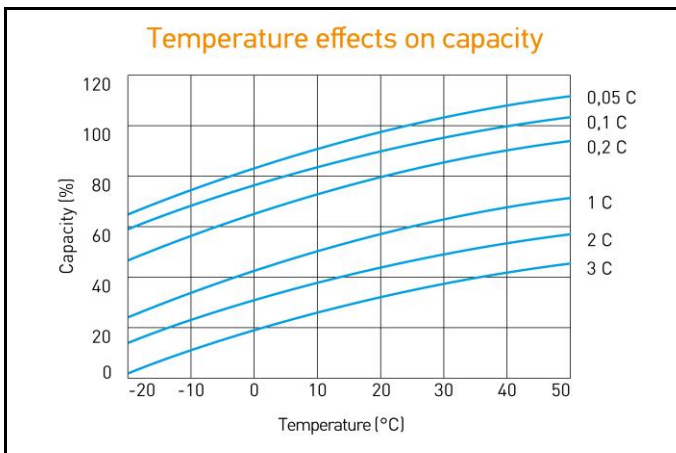

ALL DATA IS SUBJECT TO CHANGE WITHOUT NOTICE